

This product is intended for installation only by expert users. Please consult with a qualified technician for installation. Improper installation may result in damage to your equipment. EK Water Blocks assumes no liability whatsoever, expressed or implied, for the use of these products, nor their installation. The following instructions are subject to change without notice. Please visit our web site at [www.ekwb.com](http://www.ekwb.com) for updates. Before installation of this product please read important notice, disclosure and warranty conditions printed on the back of the box.

Before you start using this product please follow these basic guidelines:

1. Please carefully read the manual before through before beginning with the installation process!
2. Please remove your motherboard from the computer to assure safest mounting process in order to prevent any possible damages to your CPU and/or motherboard's circuit board (PCB).
3. The EK-HFB and EK-ACF type fittings require only a small amount of force to screw them firmly in place since the liquid seal is ensured by the rubber o-ring gaskets.
4. The use of corrosion inhibiting coolants is always recommended for any liquid cooling system.

## STEP 1: GENERAL INFORMATION. Sample picture of Radeon R9 Fury X

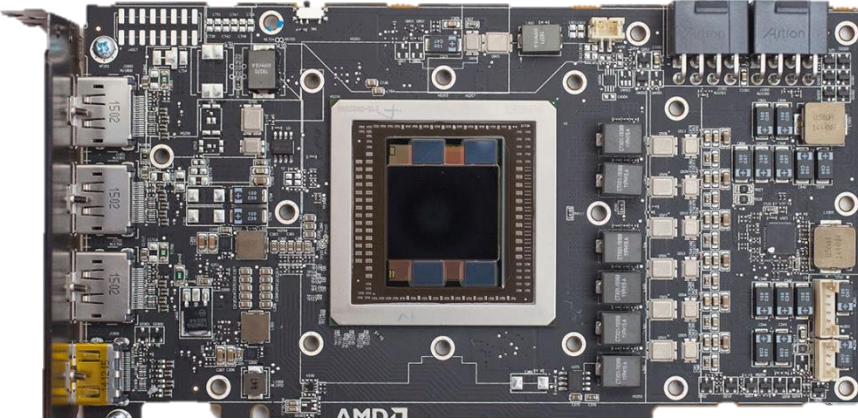

## STEP 2: PREPARING YOUR GRAPHIC CARD.

1. REMOVING STOCK COOLER and BRACKET: Remove encircled screw on the bracket. Then remove all screws from bracket.



## STEP 3 cont.: PREPARING YOUR GRAPHIC CARD

1 cont. REMOVING STOCK COOLER. Remove all encircled screws. All heat sink assembly screws should be removed, including self-adhesive washers on both sides of the PCB (if present). There are up to 17 screws on the back of the graphics card. After you remove the fan housing do not forget to unplug the fan. You may need Torx T6 screwdriver instead of Philips head screwdriver (depending on manufacturer).

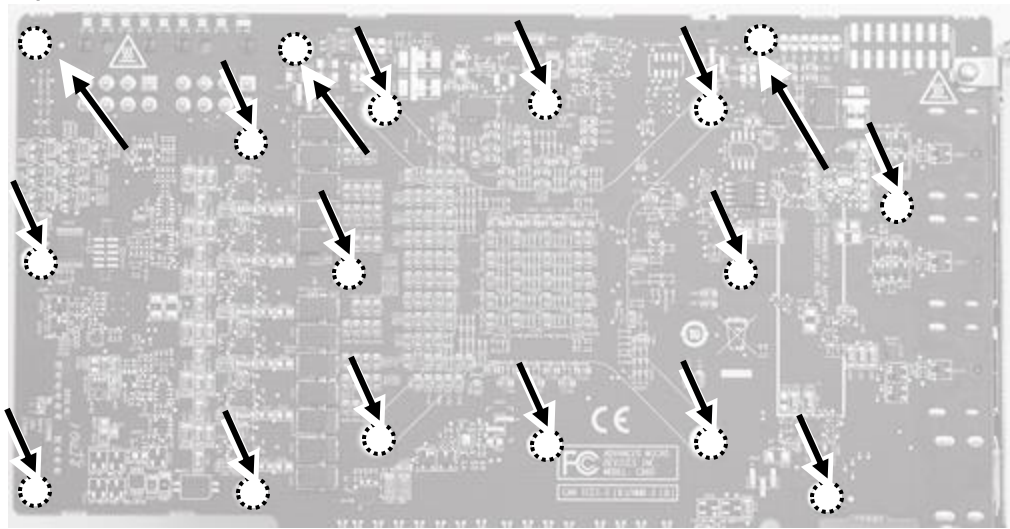

2. CLEANING THE PCB. Carefully detach the original stock cooler after removing **all** screws securing it to the board. Wipe off the remains (by using non-abrasive cloth or *qtip*, as shown on sample photo) of the original thermal compound until the components and circuit board are completely clean. EKWB recommends the use of denatured alcohol for removing TIM leftovers.



3: REPLACING THE ORIGINAL I/O BRACKET Remove two Philips screws securing the original two-slot I/O bracket to the circuit board. Remove the four screws that secure the tab of the I/O bracket to the circuit board as well. Replace the original I/O bracket with enclosed EK-FC R9 Fury X single-slot I/O bracket and install it using four original screws and use it on single slot bracket. Secure the bracket tab using M3x4 DIN7985 screw.

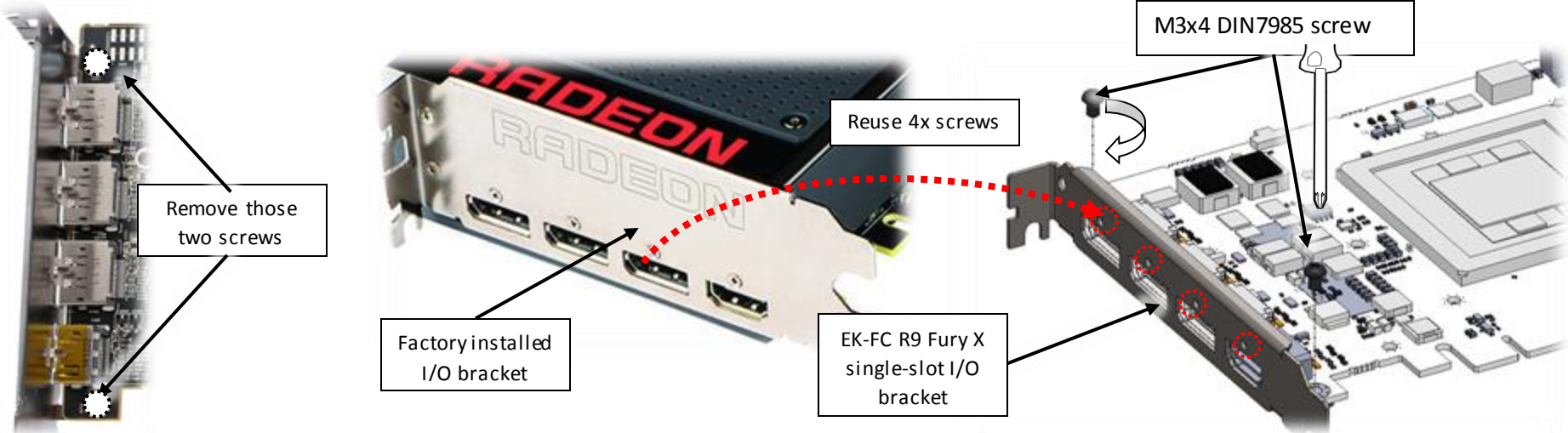

4. APPLYING THERMAL COMPOUND. Apply thermal compound: lightly coat AMD chip (GPU + HBM stack) with enclosed EK-TIM Ectotherm™ thermal grease. EKWB recommends to apply thermal grease on GPU in cross form for best performance (see sample picture). Apply dot of TIM on each HBM module die (4 pcs) as shown on picture below:

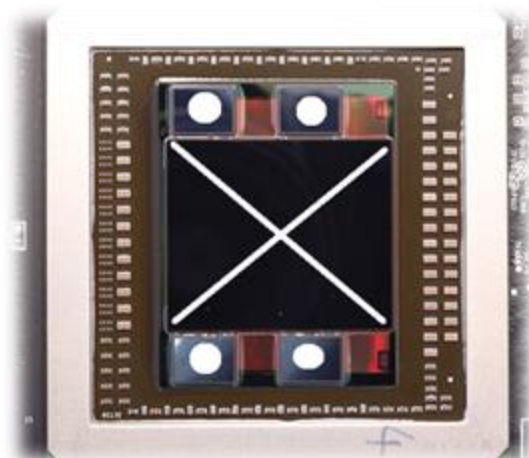

5. CUTTING THERMAL PADS. Your block comes with thermal pads, some of which are already pre-cut. Others have to be cut to smaller chunks in order to cover all the VRM components such as MOSFETs and drivers. PLEASE REMOVE THE PROTECTIVE FOIL FROM BOTH SIDES OF THE THERMAL PADS PRIOR TO INSTALLATION. Replacement thermal pads: Thermal Pad F – 0.5mm (100x16mm)

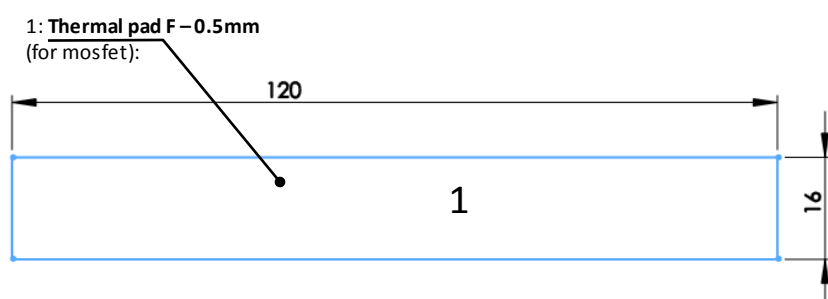

## STEP 4: INSTALLING WATER BLOCK

1. PLACING THERMAL PADS ON PCB. Place thermal pads on chips so that numbers on chips match size of thermal pads. EKWB made sure users have more than enough pads to cover all surfaces that need to be covered to make block fully functional.

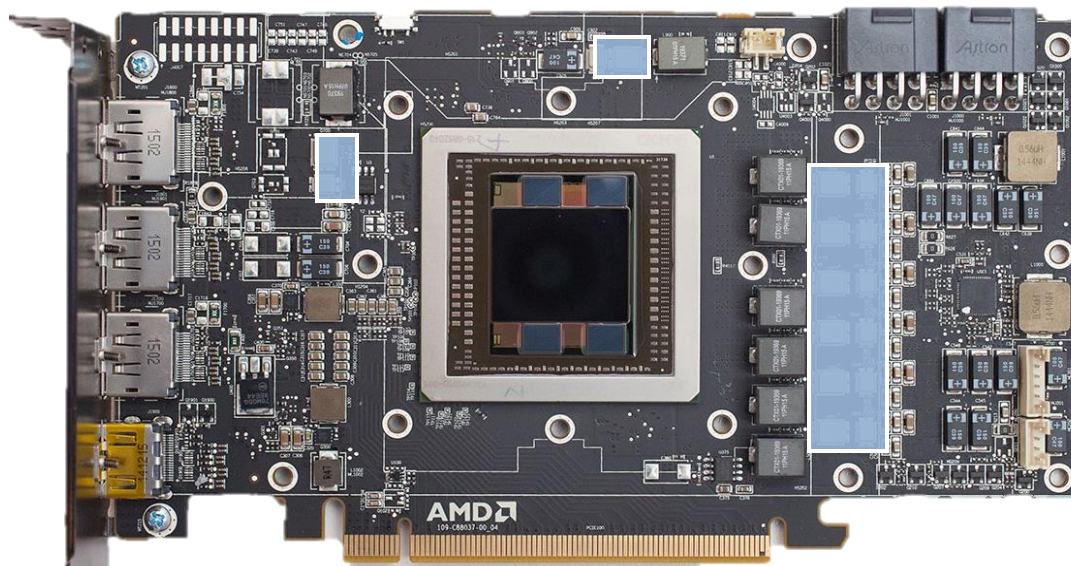

2. PLACING BLOCK TO GRAPHIC CARD. Carefully position the water block with preinstalled 2.5mm standoffs on to the graphics card. During this process please make sure you align mounting holes on PCB with holes on the water block. Also pay attention not to use too much force by pressing block down to PCB. Chip dies are prone to cracking.

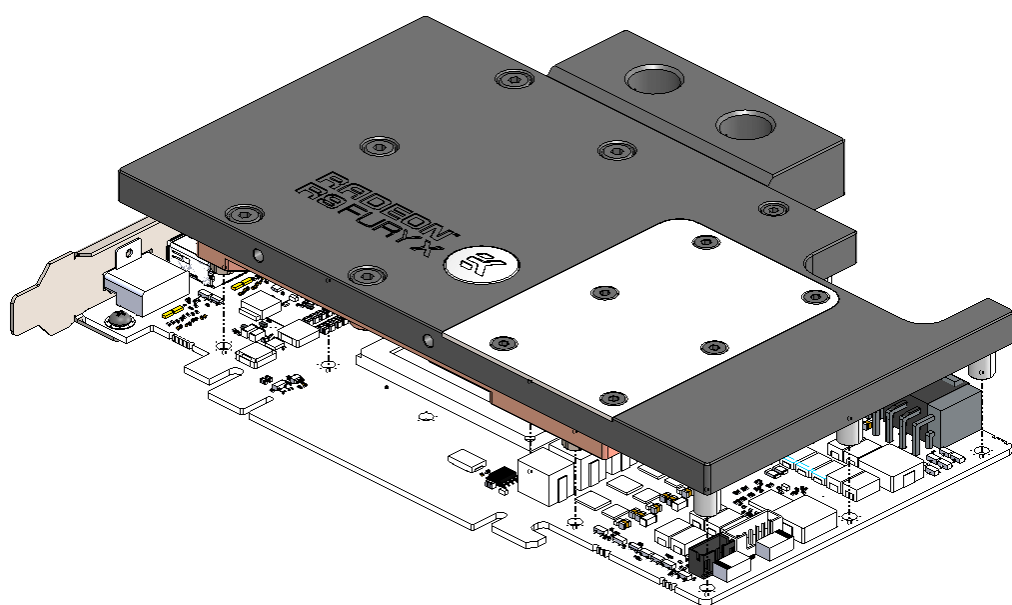

3 ATTACHING THE BLOCK TO THE GRAPHIC CARD. Use a Philips screwdriver screw with the enclosed M3x4 DIN 7985 screws. EKWB recommends users to start tightening the screws around the GPU core and continue outwards. Always use a plastic washer under each and every screw! If the washer is already present on the circuit board (usually around the four GPU core screw holes) there is no need for additional washer.

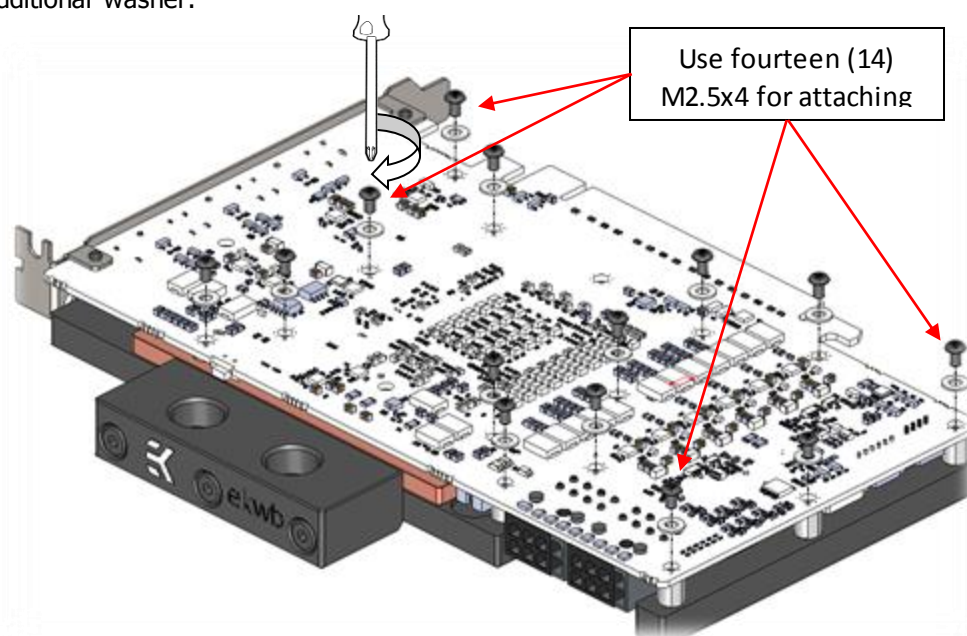

## STEP 5: CHECKING FOR CONTACTS

Temporarily remove the water block to check for uniform surface contact between the block and the components, pay special attention to the VRM section of the graphics card. Check whether the water block makes contact with the VRM. Then repeat sub-steps in previous section to re-attach the block. **In case you fail to obtain good contact, please check again your thermal pad thickness or contact our support service.**

## STEP 6: INSTALLATION OF FITTINGS AND TUBING

Screw in the two G1/4 threaded male fittings. Attach the liquid cooling tubes and connect the water-block(s) into the cooling circuit. **EKWB recommends using EK-ACF fittings with the EK-FC R9 Fury X series water blocks.**

When using fittings, other than compression type please ensure the tubes are securely attached to the barb/fittings. Use hose clamps or an appropriate substitute.

EKWB recommend to use LEFT side port as an inlet port for best performance. However this water block also operates flawlessly with reversed water flow.

**CAUTION:** In case of using connectors other than EK-ACF series compression fittings or EK-HFB barb fittings, take special attention to the length of the fittings' male G1/4" thread.

5mm is the maximum allowed G1/4" thread length!

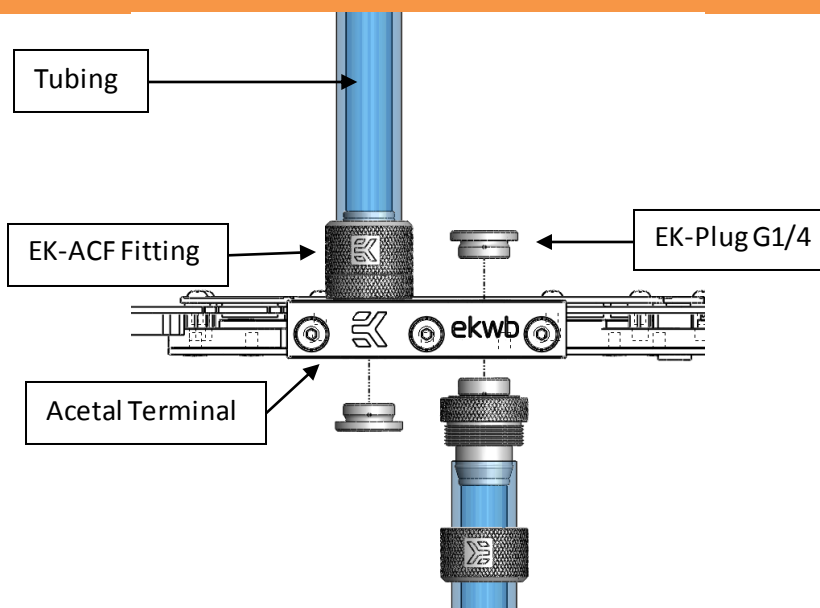

## STEP 7: INSERTING CARD IN YOUR PC CASE

Carefully lift your graphics card with installed block and insert it in your PC's motherboard PCI-express expansion slot. Please bear in mind that your graphics card is probably heavier than when it was equipped with original heat sink fan assembly. One needs to be very careful when handling the graphics card. Avoid all un-needed manipulation of the VGA/water block assembly that might damage your card or water block during final installation.

### REQUIRED TOOLS AND MOUNTING SCREWS:



scissors



philips screwdriver