

EK-Quantum Vector² Strix/TUF RTX 3090 Ti D-RGB

GPU WATER BLOCK

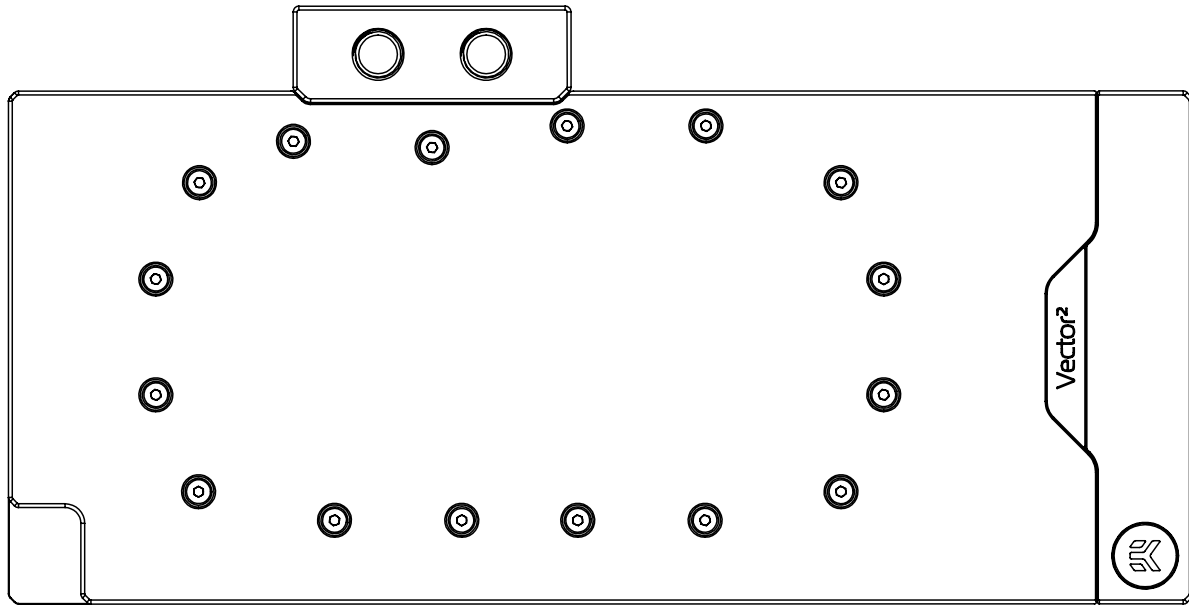

Please note the installation of the product is intended to be undertaken by an adequately trained and experienced person. You are installing the product at your own risk. If you are not properly trained or experienced or feel unsure about the installation procedure, please refrain from installing the product yourself and contact our tech support for assistance. We disclaim our liability for any damages to the product as well as incidental, consequential, or indirect damages incurred due to improper or inappropriate installation.

Before you start using this product, please follow these basic guidelines:

Carefully read the manual before beginning with the installation process.

Remove your graphics card from the computer for the safest mounting process to prevent any possible damage to your GPU or its circuit board (PCB).

The EK Fittings require only a small amount of force to screw them firmly in place since the liquid seal is ensured by the rubber O-ring gaskets.

The use of corrosion inhibiting coolants is always recommended for liquid cooling systems and mandatory for nickel-plated water blocks!

Do not use pure distilled water!





For best results, EK recommends the use of EK-CryoFuel coolants! To reach optimal performance, make sure to thoroughly bleed the air out of your water block!

TABLE OF CONTENTS

BOX CONTENTS	4
WATER BLOCK DIMENSIONS	5
TECHNICAL SPECIFICATIONS AND WATER BLOCK PARTS	6
NICKEL PLEXI	6
PREPARING THE GRAPHICS CARD	7
REMOVING THE STOCK LIQUID COOLER FROM STRIX RTX 3090 TI	7
REMOVING THE STOCK LIQUID COOLER FROM TUF RTX 3090 TI	8
CLEANING THE PCB	8
PREPARING THE WATER BLOCK FOR INSTALLATION	9
CUTTING AND PLACING THERMAL PADS	10
APPLYING THERMAL COMPOUND	11
ATTACHING THE WATER BLOCK	11
PREPARING THE BACKPLATE	13
ATTACHING THE BACKPLATE	14
INSERTING THE GRAPHICS CARD INTO THE CHASSIS	15
FITTINGS AND TUBING	15
CONNECTING THE D-RGB LED STRIP	16
TESTING THE LOOP	16
WARRANTY	17
SUPPORT AND SERVICE	18
SOCIAL MEDIA	18

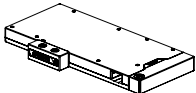
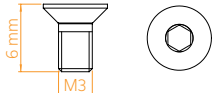
BOX CONTENTS

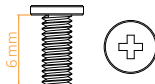
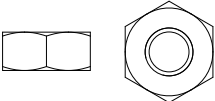
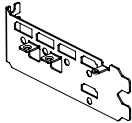
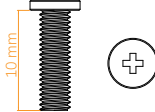
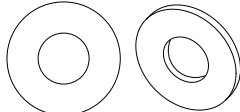
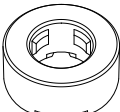
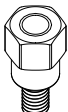
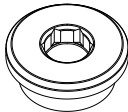
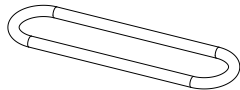
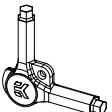
EAN: 105526

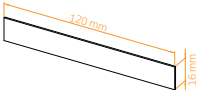
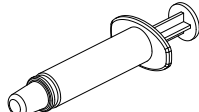
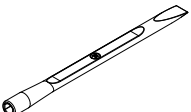
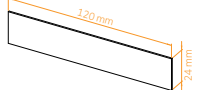
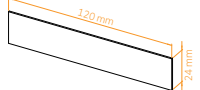
 <p>EK-Quantum Vector² Strix/TUF RTX 3090 Ti D-RGB</p>	 <p>M3 x 6 DIN7991 Screw (2 pc)</p>	 <p>M2.5x4 AX1 Screw (8 pcs)</p>	 <p>M2.5x6 AX1 Screw (1 pc)</p>
 <p>Nut M2.5 (2 pcs)</p>	 <p>Strix/TUF Double Slot Bracket (1 pc)</p>	 <p>M3x10 AX1 Screw (1 pc)</p>	 <p>Polyamid Washer M2.5 0.5mm (8 pcs)</p>
 <p>Standoff Ø4.5/2.5 (1 pc)</p>	 <p>Standoff M2.5-M3 x 6.6mm (1 pc)</p>	 <p>Quantum Plug (2 pcs)</p>	 <p>Terminal OR - Vector² 14x1 mm (2 pcs)</p>
 <p>EK-Loop Multi Allen Key (1 pc)</p>	 <p>Allen Key 2 mm (1 pc)</p>	 <p>Allen Key 2.5 mm (1 pc)</p>	 <p>Thermal Pad F 1.0 mm (6 pcs) (3830046996732)</p>
 <p>Thermal Grease (1 pc)</p>	 <p>EK-Plug Out Spludger Tool (1 pc)</p>	 <p>Thermal Pad G 1.5 mm (2 pcs) (3830046996787)</p>	 <p>Thermal Pad G 2.0 mm (4 pcs) (3830046996794)</p>

EAN: 104549

WATER BLOCK DIMENSIONS

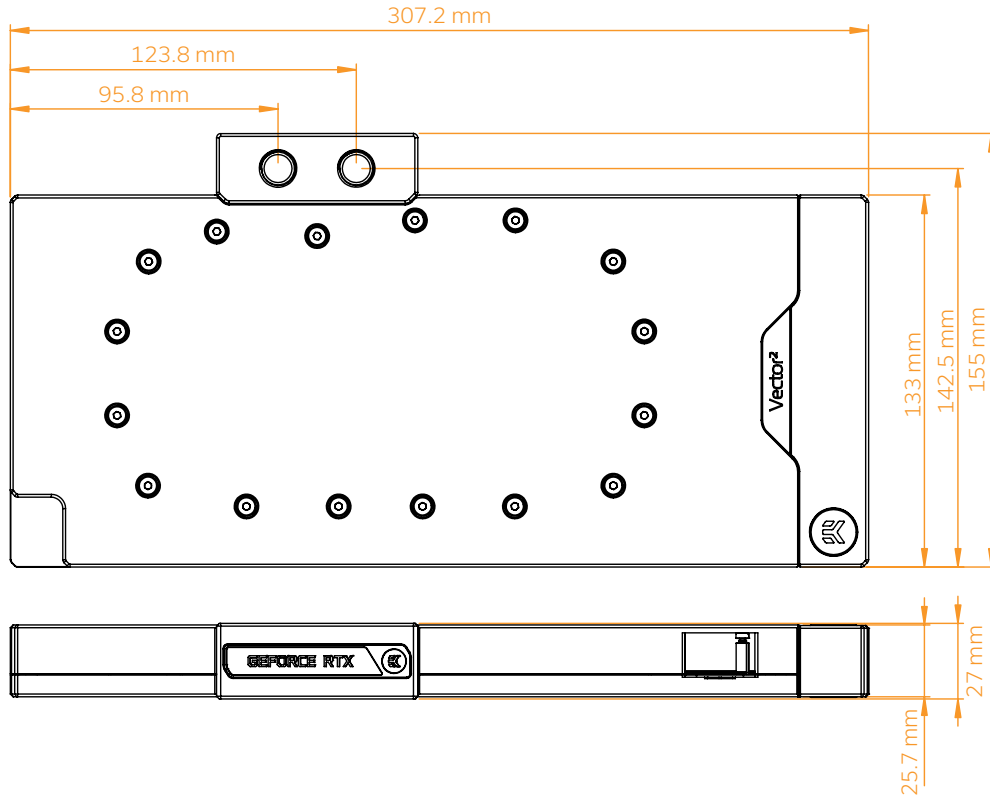

TECHNICAL SPECIFICATIONS AND WATER BLOCK PARTS

NICKEL PLEXI

- Dimensions: (L x H x W): 307.2 x 155 x 27 mm
- D-RGB LED count: 15
- D-RGB cable length: 50 cm
- D-RGB connector 3-pin 5V digital LED header

Position	EAN	Description	Quantity
1	105518	Coldplate (Nickel)	1
2	103962	Plexi insert	1
3	105523	Top plate (Plexi)	1
4	103971	Stand out (Acetal)	1
5	103986	Standoff M3.5-M2.5 x 11.3 mm	4
6	103988	Standoff M4-M2.5 x 3 mm	4
7	103987	Standoff M3.5-M2.5 x 3	5
8	104106	Terminal OR - 14 x 1 mm	2
9	104216	Disc magnet 3 x 3	2
10	103942	Terminal Badge	1
11	8311	Screw M4 x 20 DIN7984	3
12	103947	FC Terminal (Acetal)	1
13	100240	Main O-ring 165 x 2 mm	1
14	9013	Screw M4 x 8 DIN7984	16
15	8208	Screw M3 x 8 7991DIN	2
16	100663	EK - Badge	2
17	103964	Mylar sticker	2
18	105507	Backplate (Black e.)	1
19	104187	Screw M2.5 x 8 AX1	8
20	104188	Standoff fi 4.5/2.5	8
21	105510	LED Cover	1
22	105559	Strix/TUF 3090 Ti Double Slot Bracket (Black)	1
23	8472	Screw M3 x 6 7991DIN	2
24	100815	LED D-RGB strip 500/300 mm	1

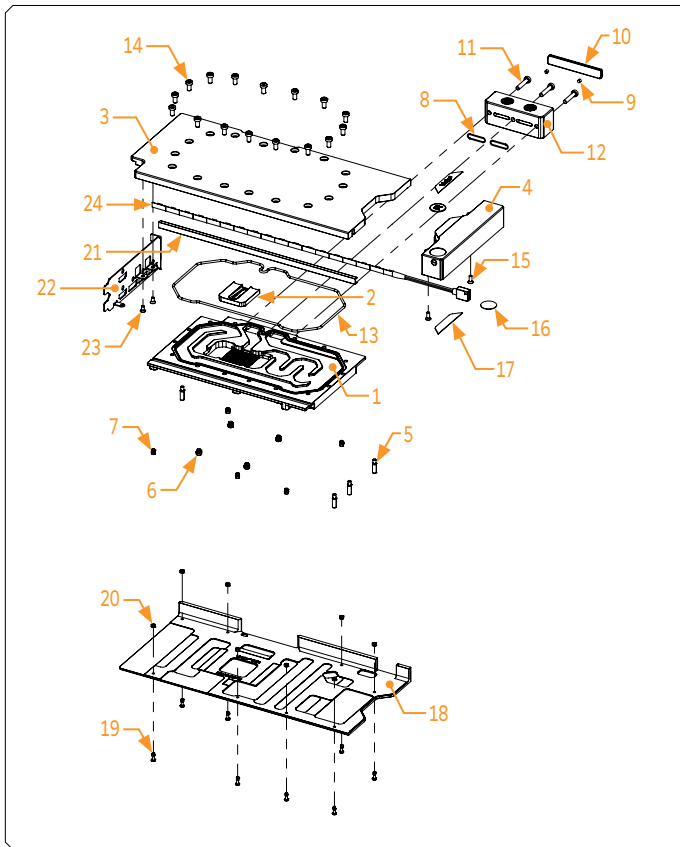

PREPARING THE GRAPHICS CARD

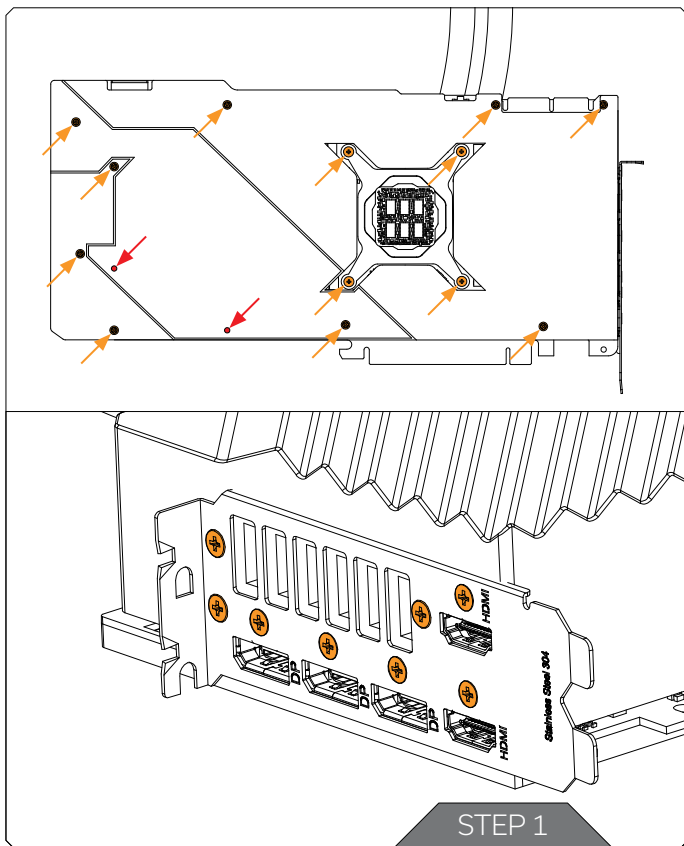

STEP 1

For this step, you will need:

Phillips Head Screwdriver

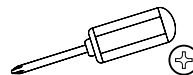

REMOVING THE STOCK LIQUID COOLER FROM STRIX RTX 3090 Ti

Use the Phillips head screwdriver to remove the thirteen (13) marked stock screws from the backside of the GPU. Two (2) screw positions, marked red need to be detached from the front side of the stock cooler. Carefully detach the Stock Cooler Backplate from the PCB.

To uninstall the cooler you will have to remove the eighth (8) stock screws from the bracket. **Save the removed screws as they are re-used in the following steps! Remove the stock I/O Bracket!**



Always remove the stock cooler slowly - it might be firmly glued to the PCB with thermal pads.

REMOVING THE STOCK LIQUID COOLER FROM TUF RTX 3090 Ti

Use the Phillips head screwdriver to remove the fifteen (15) marked stock screws from the backside of the GPU.

To uninstall the cooler you will have to remove the eighth (8) stock screws from the bracket. **Save the removed screws as they are re-used in the following steps! Remove the stock I/O Bracket!**

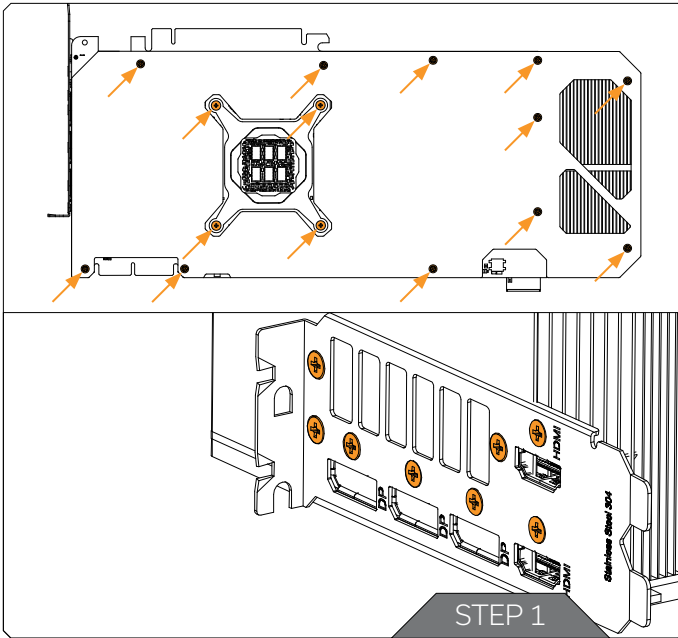

STEP 2 CLEANING THE PCB

Wipe off the remains of the original thermal compound using a nonabrasive cloth or Q-tip, as shown in the sample image, until the components and circuit board are completely clean. EK recommends the use of denatured alcohol for removing TIM leftovers. After that, remove all remaining stock thermal pads from the PCB.

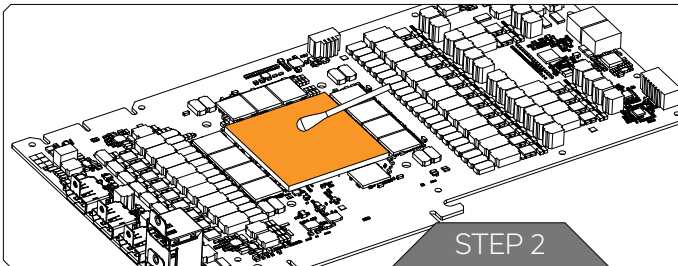

PREPARING THE WATER BLOCK FOR INSTALLATION

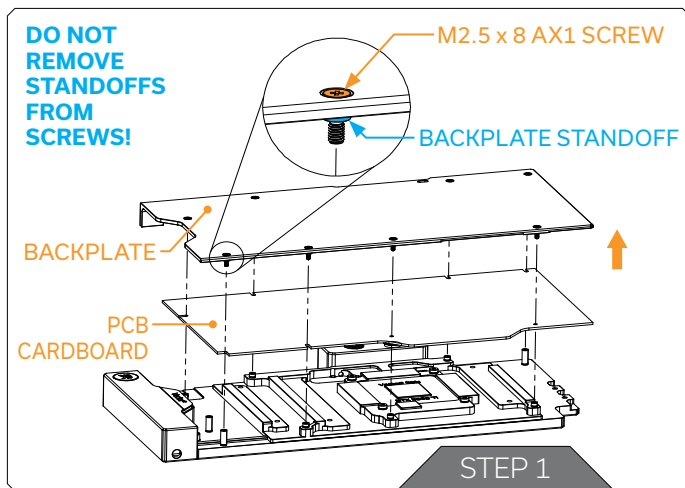

STEP 1

Unscrew eight (8) Screws AX1 M2.5 x 8 as shown in the image. Remove the backplate together with eight (8) Screws M2.5 x 8 AX1 and backplate standoffs. Standoffs must stay on Screws M2.5 x 8 AX1. Remove cardboard. Save the backplate set for later steps.



Do not remove standoffs from screws! In case the standoff detaches from the screw, replace it with a spare one. When replacing the standoff make sure that you screw it on the AX1 M2.5 x 8 screw. Do not push the standoff onto the screw AX1 M2.5 x 8!

For this step, you will need:

Phillips Head Screwdriver

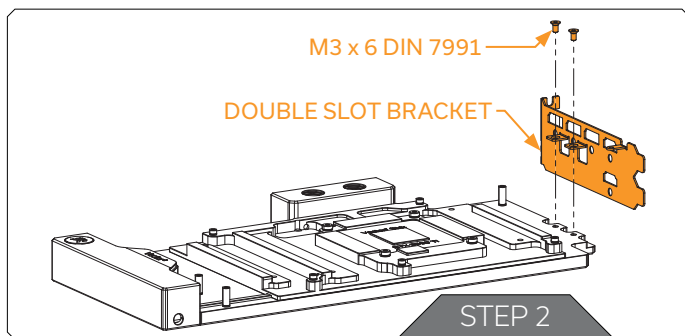
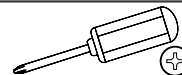

STEP 2

EK-Quantum Vector² Strix/TUF RTX 3090 Ti D-RGB - Nickel + Plexi comes with it's own custom Double Slot Bracket. Position the bracket accordingly and use Allen Key to screw in two (2) M3 x 6 DIN7991 Screws. Make sure the holes are properly aligned.

Do not use excessive force!

For this step, you will need:

Allen Key 2.5mm



CUTTING AND PLACING THERMAL PADS

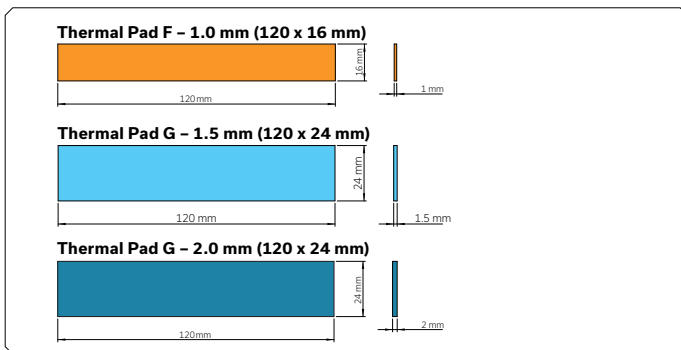

Your EK-Quantum Vector² Strix/TUF RTX 3090 Ti D-RGB block comes with Thermal Pads that have to be cut into smaller pieces to cover all the VRM components. EK made sure to provide you with more than an adequate quantity of Thermal Pads to complete this Step.



CAUTION: You must remove the protective foil from both sides of the thermal pad before installation.

Replacement thermal pads:

Thermal Pad F 1.0 mm - (120 x 16 mm) EAN: 3830046996732

Thermal Pad G 1.5 mm - (120 x 24 mm) EAN: 3830046996787

Thermal Pad G 2.0 mm - (120 x 24 mm) EAN: 3830046996794

For this step, you will need:

Scissors

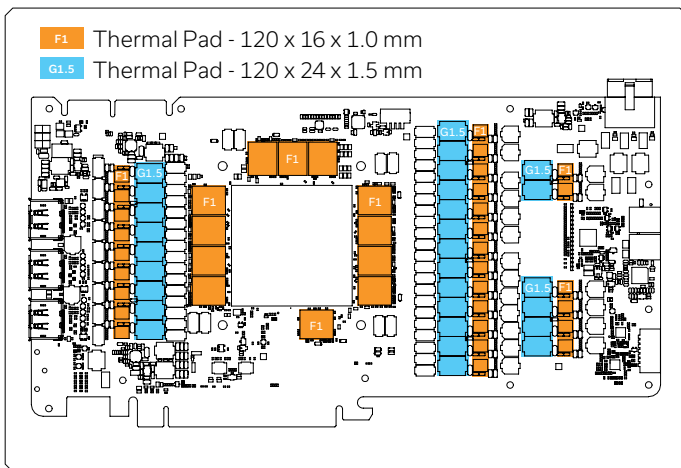
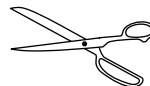

APPLYING THERMAL COMPOUND

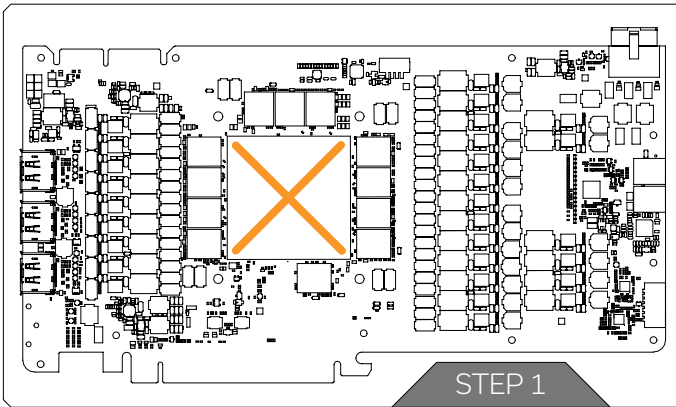

STEP 1

Apply the enclosed EK-TIM Ectotherm thermal grease (thermal compound) on the GPU heat spreader - IHS - as shown in the image. The layer of the thermal compound must be thin and even over the entire surface of the IHS.



The excessive or uneven application of thermal grease may lead to poor performance!

For this step, you will need:

Thermal Grease

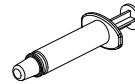

ATTACHING THE WATER BLOCK

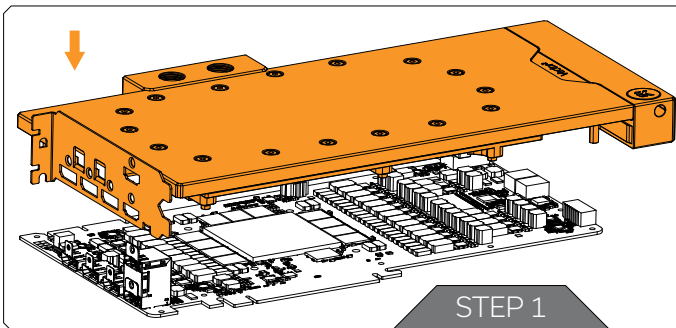

STEP 1

Carefully position the water block with preinstalled standoffs on the graphics card. During this process, make sure you have aligned mounting holes of the PCB with holes of the water block.



Pay attention not to use too much force when pressing the block down to the PCB since chip dies are prone to cracking.



Before placing the Water Block, make sure all the Thermal Pads are placed correctly!

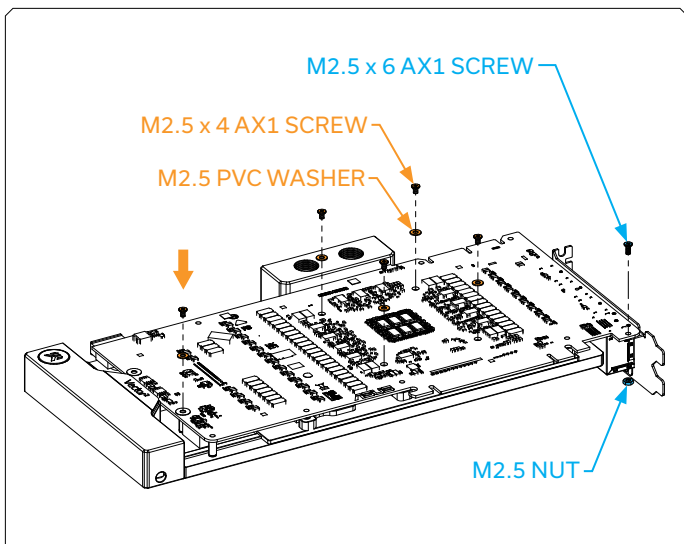

STEP 2

After placing the water block, use five (5) M2.5 x 4 AX1 screws and PVC washers to tighten the GPU PCB. Tighten the screws evenly using the Phillips-head screwdriver. EK recommends you start tightening the screws around the GPU core first and then continuing outward to prevent damaging the GPU. Always use a plastic washer under each screw.

After attaching the PCB, use one (1) M2.5 x 6 AX1 Screw in combination with (1) M2.5 Nut to secure the I/O Bracket.

For this step, you will need:

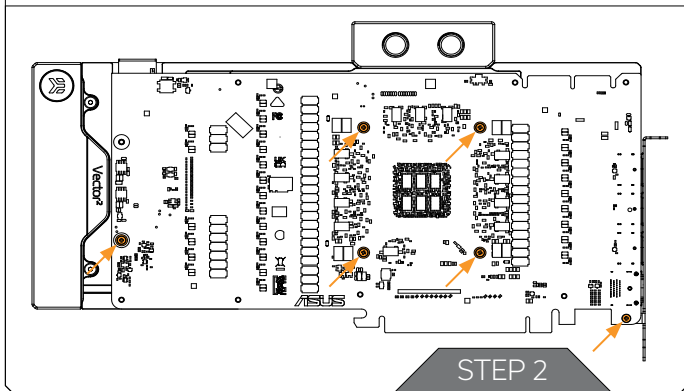
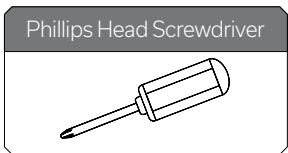

Screws must be present in the places marked on the picture.

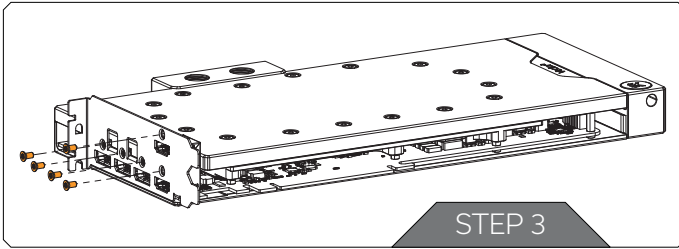

STEP 3

Use five (5) of the original stock screws to secure Double Slot Bracket onto the IO of the PCB.

PREPARING THE BACKPLATE

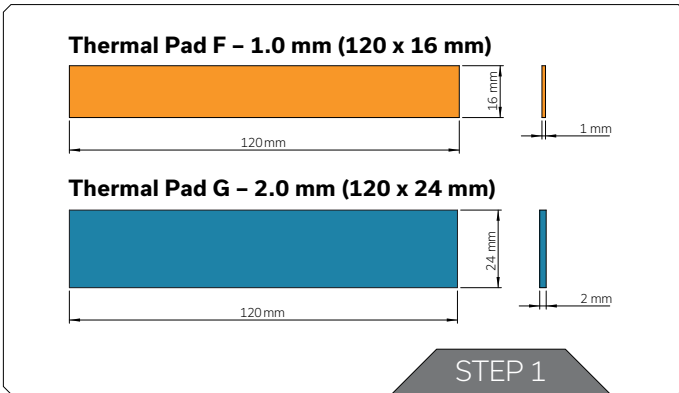

STEP 1

After attaching the water block, a few more thermal pads need to be cut into smaller pieces to cover all the necessary components.

EK made sure to provide you with more than an adequate quantity of thermal pads to complete this step.



CAUTION: You must remove the protective foil from both sides of the thermal pad before installation.

Replacement thermal pads:

Thermal Pad F 1.0 mm – (120 x 16 mm) EAN: 3830046996732

Thermal Pad G 2.0 mm – (120 x 24 mm) EAN: 3830046996794

For this step, you will need:

Scissors



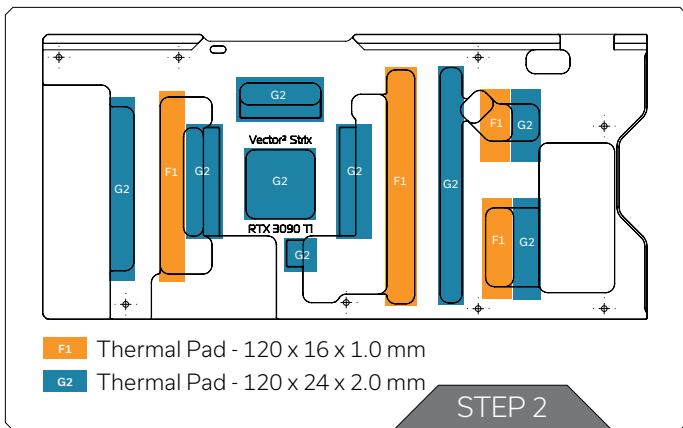

STEP 2

Apply the thermal pads onto the backplate as shown in the image.

ATTACHING THE BACKPLATE

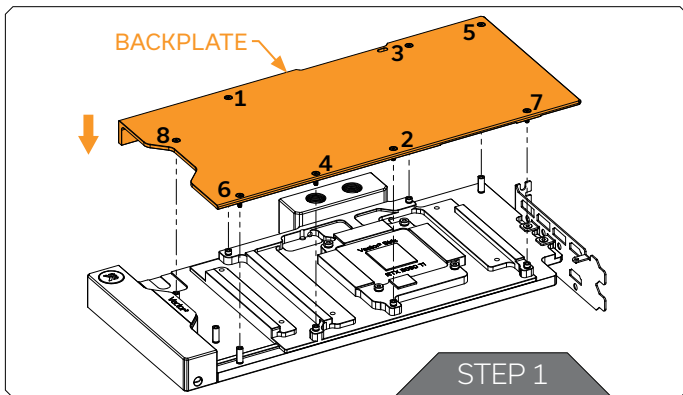

STEP 1

Place the backplate with eight (8) M2.5 x 8 AX1 Screws and Standoffs onto the PCB. Make sure all the holes are aligned.

Tighten the screws according to the numerical order shown in the image!

Do not use excessive force!

For this step, you will need:

Phillips Head Screwdriver

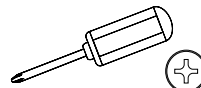

INSERTING THE GRAPHICS CARD INTO THE CHASSIS

Carefully lift your graphics card with the installed water block and insert it into your PC's motherboard PCI Express expansion slot. Please keep in mind that your graphics card is heavier than before it was equipped with the water block.



You need to be very careful when handling the graphics card. Avoid all unnecessary manipulation of the water block assembly that might damage your card or water block.

FITTINGS AND TUBING

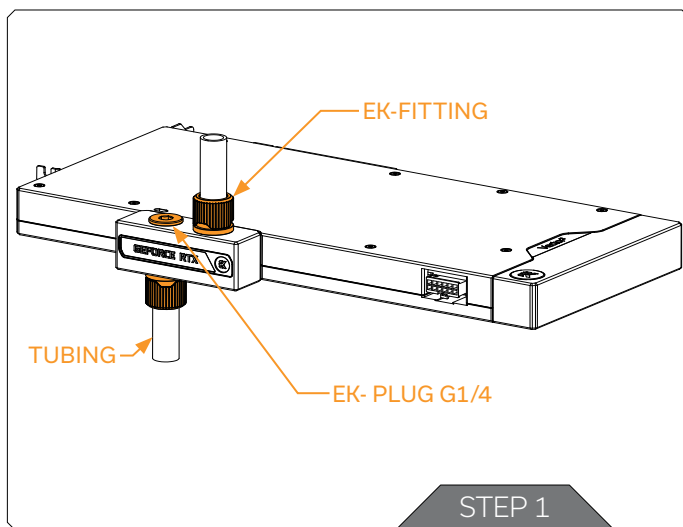

STEP 1

Screw-in two (2) G1/4 threaded male fittings. Attach the liquid cooling tubes and connect the water block to the cooling loop.



Do not forget to plug the remaining two openings with enclosed EK-Plug G1/4 or its equivalent.

EK recommends using EK fittings with all EK water blocks.



CAUTION: When using connectors other than EK fittings, pay special attention to the length of the fittings' male G1/4" thread - 5mm is the maximum G1/4" thread length allowed!

For this step, you will need:

EK-Loop Multi Allen Key

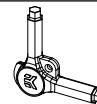

CONNECTING THE D-RGB LED STRIP

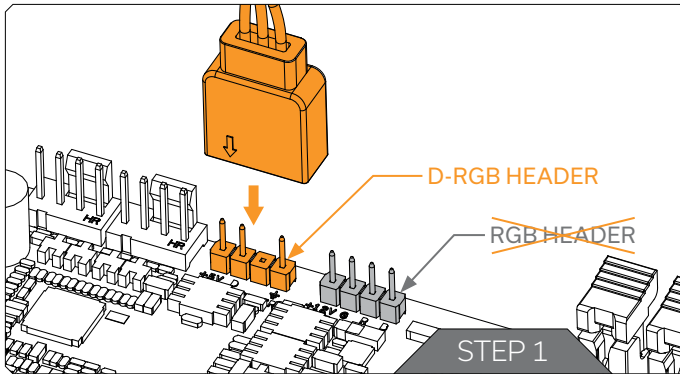

STEP 1

Plug the **3-pin connector** of the distribution plate D-RGB LED light to the **D-RGB HEADER** on the motherboard. The LED will work if the pin layout on the header is as follows: **+5V, Digital, Empty, Ground**.



Incorrect installation or installation to a wrong header can damage the LED strip or the header itself!

TESTING THE LOOP

To make sure the installation of EK components was successful, we recommend you perform a leak test for 24 hours. When your loop is complete and filled with coolant, connect the pump to a PSU outside of your system. Do not connect power to any of the other components. Turn on the PSU and let the pump run continuously. It is normal for the coolant level to drop during this process as air collects in the distribution plate. Inspect all parts of the loop, and in the eventuality that coolant leaks, fix the issue and repeat the testing process. Ensure that all hardware is dry before the system is powered on in order to prevent any damage.

WARRANTY

Our products are warranted against defects of materials and quality for a period of 24 months, starting with the date of delivery to the end-user. During this period, products will be repaired or have parts replaced at our discretion, provided that 1) the product is returned to the agent from whom it was purchased; 2) the product has been purchased by the end-user and has not been used for commercial purposes; 3) the product has not been misused, handled carelessly, or used in a manner other than the way described in the instructions manual. This warranty does not confer rights other than those expressly set out above and does not cover any claims for consequential loss or damage. This warranty is offered as an extra benefit and does not affect your statutory rights as a consumer. This warranty is voided if the product comes in contact with aggressive UV additives or other improper liquids. EK water blocks are sealed with a warranty-voiding circular label, proving the water block has withstood a pressure leak test. Removing the label will void the leak-free guarantee, but not the guarantee on the product itself. Any other RMA issues can be reported to EK Customer Support at www.ekwb.com/support for further analysis.

SUPPORT AND SERVICE

In case you need assistance or wish to order spare parts or a new mounting mechanism, please contact:

<https://www.ekwb.com/customer-support/>

For spare parts orders, refer to the page with "TECHNICAL SPECIFICATIONS AND WATER BLOCK PARTS" where you can find the EAN number of each part you might need.

Include the EAN number with quantity in your request. Mounting Mechanism EAN can be found under "BOX CONTENTS"

Thermal pads are readily available in the EK shop

SOCIAL MEDIA

 EKWaterBlocks

 @EKWaterBlocks

 ekwaterblocks

 EKWBofficial

 ekwaterblocks

